

TPDxEUSB30 用于超高速 USB 3.0 接口的 2、4 通道 ESD 保护

1 特性

- 支持 USB 3.0 数据速率 (5Gbps)
- IEC 61000-4-2 ESD 保护 (4 级接触式)
- IEC 61000-4-5 浪涌保护
 - 5A (8/20 μ s)
- 低电容
 - DRT : 0.7pF (典型值)
 - DQA : 0.8pF (典型值)
- 动态电阻 : 0.6 Ω (典型值)
- 节省空间的 DRT、DQA 封装
- 直通引脚映射

2 应用

- 笔记本电脑
- 机顶盒
- DVD 播放器
- 媒体播放器
- 便携式计算机

3 说明

TPD2EUSB30、TPD2EUSB30A 和 TPD4EUSB30 是基于 2 通道和 4 通道瞬态电压抑制器 (TVS) 的静电放电 (ESD) 保护二极管阵列。TPDxEUSB30/A 器件的额定 ESD 冲击消散值达到了 IEC 61000-4-2 国际标准 (接触式) 规定的最高水平。根据 IEC 61000-4-5 (浪涌) 规范, 这类器件还可提供 5A (8/20 μ s) 的峰值脉冲电流额定值。

TPD2EUSB30A 具有 4.5V 的低直流击穿电压。凭借低电容、低击穿电压和低动态电阻, TPD2EUSB30A 器件可为高速差分 IO 提供出色的保护。

TPD2EUSB30 和 TPD2EUSB30A 可采用节省空间的 DRT (1mm \times 1mm) 封装。TPD4EUSB30 可采用节省空间的 DQA (2.5mm \times 1.0mm) 封装。

器件信息⁽¹⁾

器件型号	封装	封装尺寸 (标称值)
TPD2EUSB30	SOT (3)	1.00mm \times 0.80mm
TPD2EUSB30A		
TPD4EUSB30	USON (10)	2.50mm \times 1.00mm

(1) 如需了解所有可用封装, 请参阅数据表末尾的可订购产品附录。

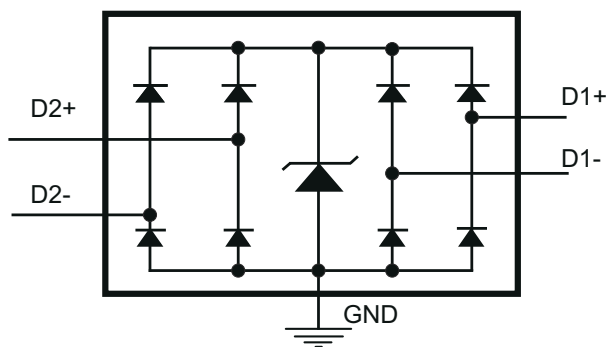

TPD4EUSB30 电路

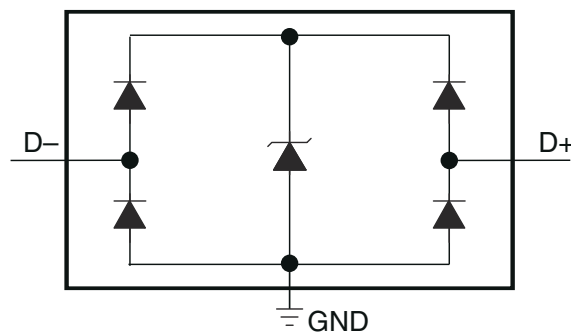

TPD2EUSB30/A 电路



Table of Contents

1 特性.....	1	7.4 Device Functional Modes.....	8
2 应用.....	1	8 Application and Implementation.....	9
3 说明.....	1	8.1 Application Information.....	9
4 Revision History.....	2	8.2 Typical Application.....	9
5 Pin Configuration and Functions.....	3	9 Power Supply Recommendations.....	11
6 Specifications.....	4	10 Layout.....	11
6.1 Absolute Maximum Ratings.....	4	10.1 Layout Guidelines.....	11
6.2 ESD Ratings.....	4	10.2 Layout Examples.....	12
6.3 Recommended Operating Conditions.....	4	11 Device and Documentation Support.....	14
6.4 Thermal Information.....	4	11.1 接收文档更新通知.....	14
6.5 Electrical Characteristics.....	5	11.2 支持资源.....	14
6.6 Typical Characteristics.....	6	11.3 Trademarks.....	14
7 Detailed Description.....	8	11.4 Electrostatic Discharge Caution.....	14
7.1 Overview.....	8	11.5 术语表.....	14
7.2 Functional Block Diagrams.....	8	12 Mechanical, Packaging, and Orderable Information.....	14
7.3 Feature Description.....	8		

4 Revision History

注：以前版本的页码可能与当前版本的页码不同

Changes from Revision F (October 2015) to Revision G (June 2021)	Page
• 更新了整个文档的表、图和交叉参考的编号格式.....	1
• Changed the <i>Pin Functions</i> table to clarify pin order and function.....	3
Changes from Revision E (August 2014) to Revision F (October 2015)	Page
• Moved the storage temperature to the <i>Absolute Maximum Ratings</i> table and updated the <i>Handling Ratings</i> table to an <i>ESD Ratings</i> table.....	4
• Added test condition frequency to capacitance	5
Changes from Revision D (August 2012) to Revision E (July 2014)	Page
• 添加了处理额定值表、特性说明部分、器件功能模式、应用和实施部分、电源相关建议部分、布局部分、器件和文档支持部分以及机械、封装和可订购信息部分.....	1
Changes from Revision C (December 2011) to Revision D (August 2012)	Page
• 更新了动态电阻值.....	1
• Updated Dynamic Resistance value.....	5
Changes from Revision B (July 2011) to Revision C (December 2011)	Page
• Added Insertion Loss graphic to TYPICAL OPERATING CHARACTERISTICS section.....	6
Changes from Revision A (December 2010) to Revision B (July 2011)	Page
• Changed TOP-SIDE MARKING column in the Ordering Information Table	3
Changes from Revision * (August 2010) to Revision A (December 2010)	Page
• 向文档添加了 TPS2EUSB30A 器件.....	1

5 Pin Configuration and Functions



图 5-1. DRT Package 3-Pin SOT Top View



图 5-2. DQA Package 10-Pin USON Top View

表 5-1. Pin Functions

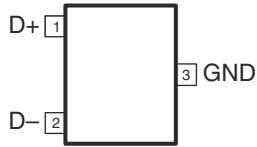
NAME	PIN		TYPE	DESCRIPTION
	DRT	DQA		
D1+	1	1	ESD port	High-speed ESD clamp, provides ESD protection to the high-speed differential data lines.
D1-	2	2		
D2+	—	4		
D2-	—	5		
GND	3	3, 8	GND	Ground
N.C.	—	6, 7, 9, 10	—	Not normally connected

6 Specifications

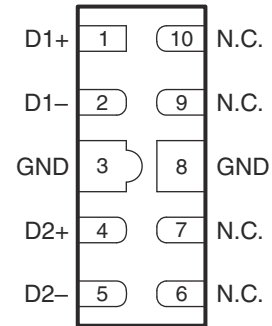
6.1 Absolute Maximum Ratings

over operating free-air temperature range (unless otherwise noted)⁽¹⁾

		MIN	MAX	UNIT
IO voltage (D+ and D- pins)	TPD2EUSB30, TPD4EUSB30	0	6	V
	TPD2EUSB30A	0	4	
IEC 61000-4-5 surge current ($t_p = 8/20 \mu s$)	D+, D - pins		5	A
IEC 61000-4-5 surge peak power ($t_p = 8/20 \mu s$)	D+, D - pins		45	W
T_A Operating free-air temperature		- 40	85	°C
T_{stg} Storage temperature		- 65	125	°C

- (1) Stresses beyond those listed under Absolute Maximum Ratings may cause permanent damage to the device. These are stress ratings only, and functional operation of the device at these or any other conditions beyond those indicated in the operational sections of the specifications is not implied. Exposure to absolute maximum-rated conditions for extended periods may affect device reliability.

6.2 ESD Ratings

		VALUE	UNIT	
$V_{(ESD)}$ Electrostatic discharge	Human body model (HBM), per ANSI/ESDA/JEDEC JS-001, all pins ⁽¹⁾	2500	V	
	Charged device model (CDM), per JEDEC specification JESD22-C101, all pins ⁽²⁾	1500		
	IEC 61000-4-2 Contact Discharge	D+, D - pins		8000
	IEC 61000-4-2 Air-Gap Discharge (TPD2EUSB30/A)	D+, D - pins		8000
	IEC 61000-4-2 Air-Gap Discharge (TPD4EUSB30)	D+, D - pins		9000

- (1) JEDEC document JEP155 states that 500-V HBM allows safe manufacturing with a standard ESD control process.
 (2) JEDEC document JEP157 states that 250-V CDM allows safe manufacturing with a standard ESD control process.

6.3 Recommended Operating Conditions

over operating free-air temperature range (unless otherwise noted)

		MIN	MAX	UNIT
T_A operating free-air temperature		- 40	85	°C
Operating Voltage	TPD2EUSB30, TPD4EUSB30	0	5.5	V
	TPD2EUSB30A	0	3.6	

6.4 Thermal Information

THERMAL METRIC ⁽¹⁾		TPD2EUSB30	TPD2EUSB30A	TPD4EUSB30	UNIT
		DRT (SOT)	DRT (SOT)	DQA (USON)	
		3 PINS	3 PINS	10 PINS	
$R_{\theta JA}$	Junction-to-ambient thermal resistance	610.2	610.2	162.2	°C/W
$R_{\theta JC(top)}$	Junction-to-case (top) thermal resistance	288.0	288.0	128.3	°C/W
$R_{\theta JB}$	Junction-to-board thermal resistance	118.4	118.4	56.7	°C/W
ψ_{JT}	Junction-to-top characterization parameter	20.2	20.2	13.8	°C/W
ψ_{JB}	Junction-to-board characterization parameter	116.4	116.4	56.6	°C/W
$R_{\theta JC(bot)}$	Junction-to-case (bottom) thermal resistance	N/A	N/A	8.1	°C/W

- (1) For more information about traditional and new thermal metrics, see the *Semiconductor and IC Package Thermal Metrics* application report, [SPRA953](#).

6.5 Electrical Characteristics

over operating free-air temperature range (unless otherwise noted)

PARAMETER		TEST CONDITIONS		MIN	TYP	MAX	UNIT
V_{RWM}	Reverse stand-off voltage (D+ and D- pins)	TPD2EUSB30, TPD4EUSB30				5.5	V
		TPD2EUSB30A				3.6	V
V_{clamp}	Clamp voltage	D+,D - pins to ground, $I_{IO} = 1$ A				8	V
I_{IO}	Current from IO port to supply pins	$V_{IO} = 2.5$ V,	$I_D = 8$ mA		0.01	0.1	μ A
V_D	Diode forward voltage	D+,D - pins, lower clamp diode,	$V_{IO} = 2.5$ V, $I_D = 8$ mA	0.6	0.8	0.95	V
R_{dyn}	Dynamic resistance	D+,D - pins	$I = 1$ A		0.6		Ω
C_{IO-IO}	Capacitance IO to IO	D+,D - pins $V_{IO} = 2.5$ V; $f = 100$ kHz			0.05		pF
C_{IO-GND}	Capacitance IO to GND	D+,D - pins (DRT)			0.7		pF
		D1+, D1-, D2+, D2- (DQA)		$V_{IO} = 2.5$ V; $f = 100$ kHz	0.8		
V_{BR}	Break-down voltage, TPD2EUSB30, TPD4EUSB30	$I_{IO} = 1$ mA		7			V
	Break-down voltage, TPD2EUSB30A	$I_{IO} = 1$ mA		4.5			V

6.6 Typical Characteristics

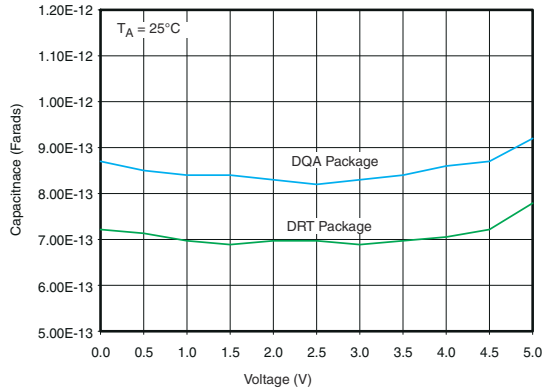

$T_A = 25^\circ\text{C}$

图 6-1. IO Capacitance vs IO Voltage

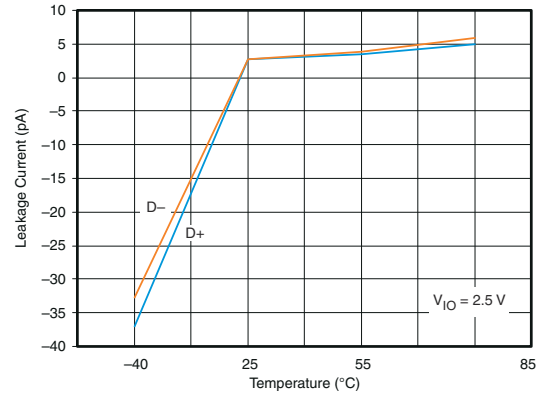

$V_{IO} = 2.5\text{ V}$

图 6-2. Leakage Current vs Temperature

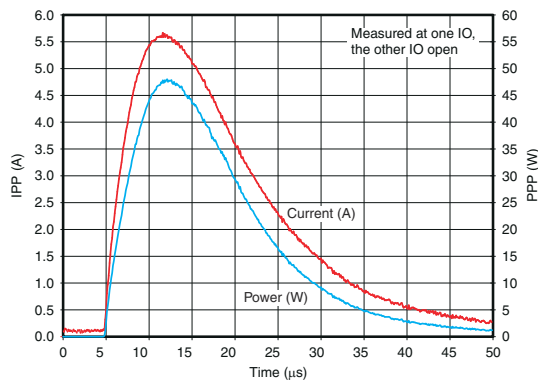

Measured at one IO, the other IO open

图 6-3. Peak Pulse Waveforms



图 6-4. D+, D- Transmission Line Pulsar Plot for TPD2EUSB30 (100 ns Pulse, 10 ns Rise Time)



图 6-5. IEC Clamping Waveforms (8 kV Contact)

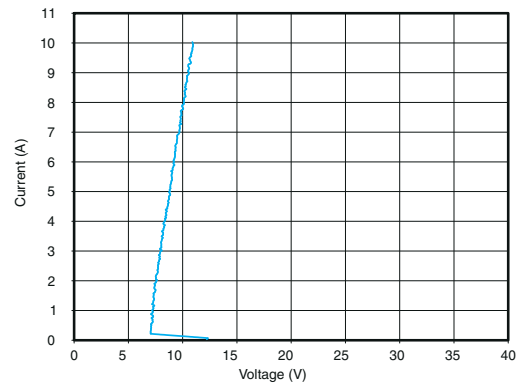

图 6-6. IEC Clamping Waveforms (- 8 kV Contact)

6.6 Typical Characteristics (continued)

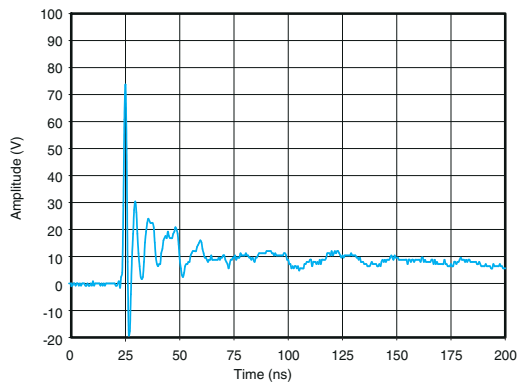

图 6-7. Insertion Loss

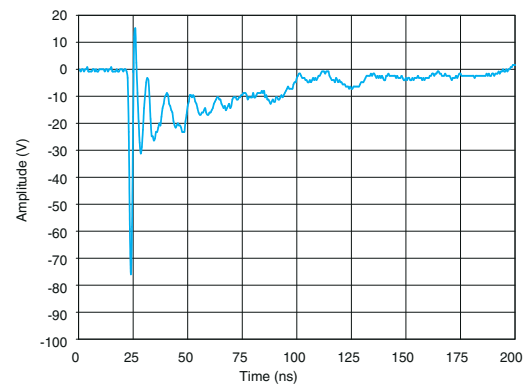
7 Detailed Description

7.1 Overview

The TPD2EUSB30, TPD2EUSB30A, and TPD4EUSB30 are 2 and 4 channel Transient Voltage Suppressor (TVS) based Electrostatic Discharge (ESD) protection diode arrays. The TPDxEUSB30/A devices are rated to dissipate ESD strikes at the maximum contact level specified in the IEC 61000-4-2 international standard (Contact). These devices also offer 5 A (8/20 μ s) peak pulse current ratings per IEC 61000-4-5 (surge) specification.

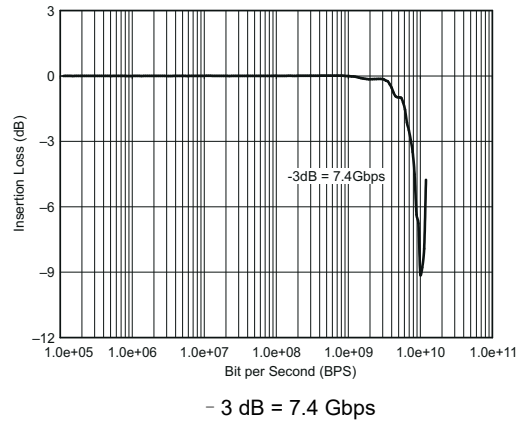
7.2 Functional Block Diagrams



图 7-1. TPD4EUSB30 Circuit



图 7-2. TPD2EUSB30/A Circuit

7.3 Feature Description

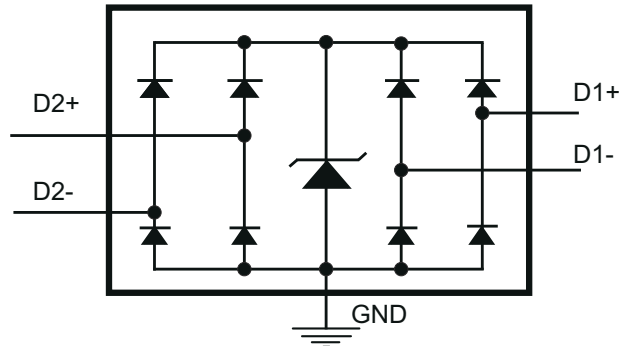
TPDxEUSB30/A is a family of uni-directional Electrostatic Discharge (ESD) protection devices with low capacitance. Each IO line is rated to dissipate ESD strikes at or above the maximum level specified in the IEC 61000-4-2 (Level 4 Contact) international standard. The TPDxEUSB30/A's low loading capacitance makes it ideal for protection super speed high-speed signals.

7.4 Device Functional Modes

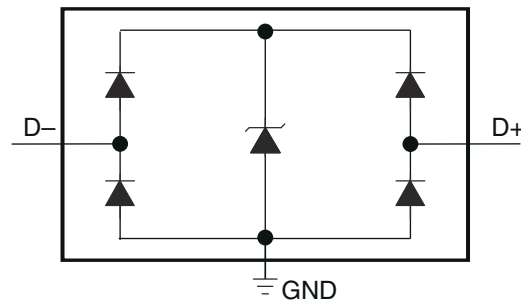
The TPDxEUSB30/A family of devices are passive integrated circuits that activate whenever voltages above V_{BR} or below the lower diodes $V_{forward}$ ($-0.6V$) are present upon the circuit being protected. During ESD events, voltages as high as ± 8 kV (contact) can be directed to ground via the internal diode network. Once the voltages on the protected lines fall below the trigger voltage of the device (usually within 10's of nano-seconds) the device reverts to passive.

8 Application and Implementation

备注

以下应用部分中的信息不属于 TI 器件规格的范围，TI 不担保其准确性和完整性。TI 的客户应负责确定器件是否适用于其应用。客户应验证并测试其设计，以确保系统功能。

8.1 Application Information

The TPDxEUSB30/A family is a family of diode array type transient voltage suppressors (TVS) which are typically used to provide a path to ground for dissipating ESD events on hi-speed signal lines between a human interface connector and a system. As the current from ESD passes through the TVS, only a small voltage drop is present across the diode. This is the voltage presented to the protected IC. The low R_{DYN} of the triggered TVS holds this voltage, V_{CLAMP} , to a tolerable level to the protected IC.

8.2 Typical Application

This application describes a TPDxEUSB30/A eye pattern test. 图 10-2 shows the lab board that was designed to demonstrate the degradation of the eye pattern quality with and without the TPD2EUSB30/A in the USB 3.0 signal path. The measurements show that there is only ~2 ps jitter penalty to the differential signal when the TPD2EUSB30/A device is added in the signal path. A similar setup was employed to measure the eye diagram for the TPD4EUSB30.



图 8-1. Measurement Setup to collect the Eye Pattern on a Reference Board with TPD2EUSB30/A



图 8-2. Measurement Setup to collect the Eye Pattern on a Reference Board with TPD2EUSB30/A

8.2.1 Design Requirements

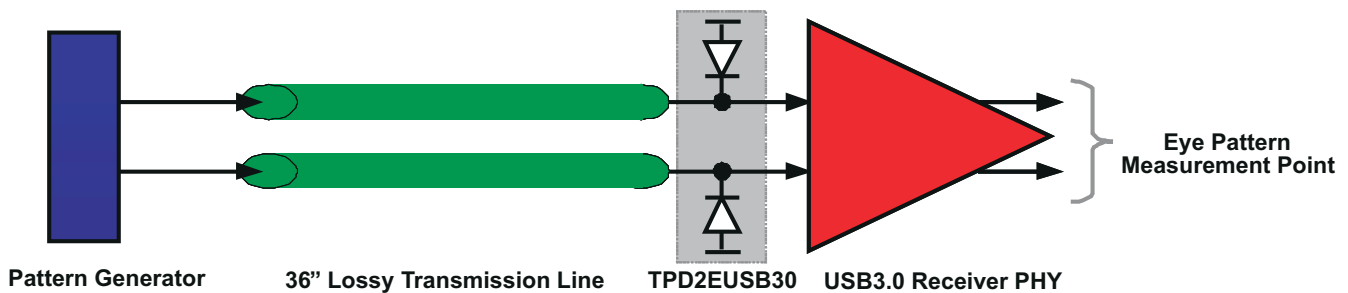
For this design example, a single TPD2EUSB30/A is used to protect a differential data pair lines, similar to a USB 3.0 application. Given the USB application, the following parameters are known.

表 8-1. Design Parameters

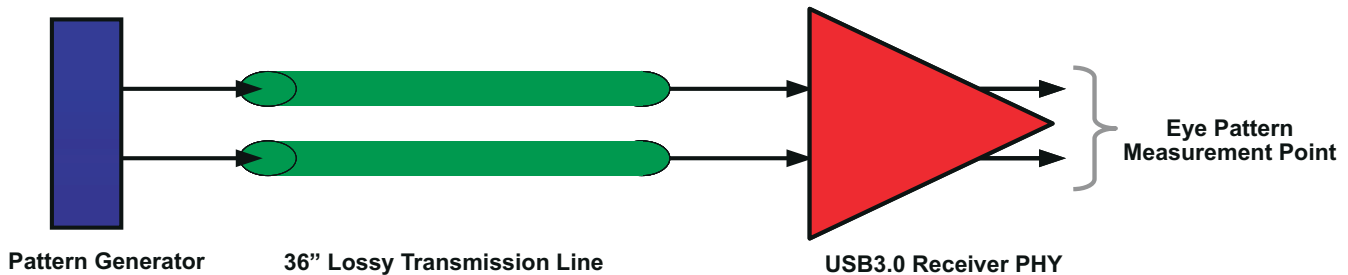
DESIGN PARAMETER	VALUE
Signal range on D+, and D -	0 V to 3.3 V
Operating Frequency	2.5 GHz

8.2.2 Detailed Design Procedure

To begin the design process, some parameters must be decided upon; the designer needs to know the following:

- Signal range on all the protected lines
- Operating frequency

8.2.2.1 Signal Range on D+, D- Pins

The TPD2EUSB30 has 2 pins which support 0 to 5.5 V and the TPD2EUSB30A has 2 pins which support 0 to 3.6 V.

8.2.2.2 Operating Frequency

The 0.7 pF (TPD2EUSB30/A typ) line capacitance supports data rates in excess of 5 Gbps.

8.2.3 Application Curves



图 8-3. Output Eye Diagram Without TPD2EUSB30/A (图 8-2 Setup, 5 Gbps Data Rate)



图 8-4. Output Eye Diagram With the TPD2EUSB30/A (图 8-2 Setup, 5 Gbps Data Rate)

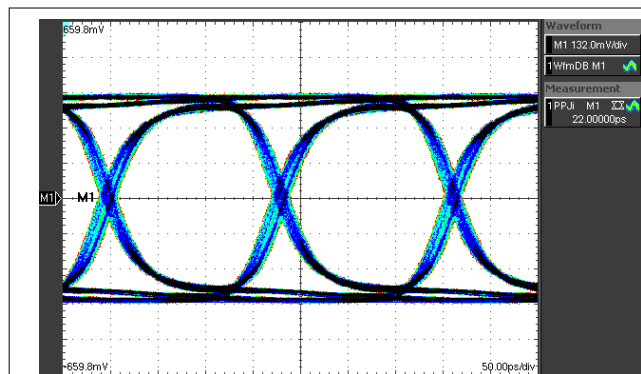

图 8-5. Output Eye Diagram Without the TPD4EUSB30 (5 Gbps Data Rate)

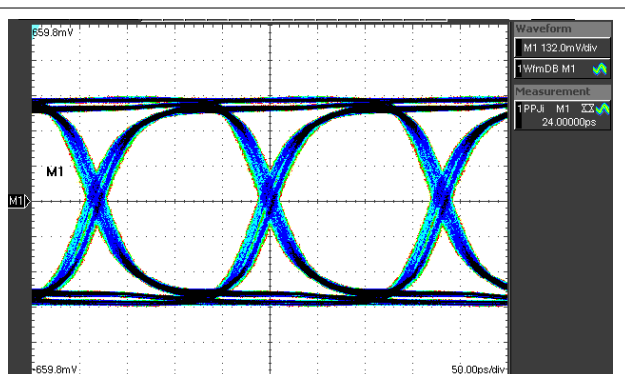

图 8-6. Output Eye Diagram with the TPD4EUSB30 (5 Gbps Data Rate)

9 Power Supply Recommendations

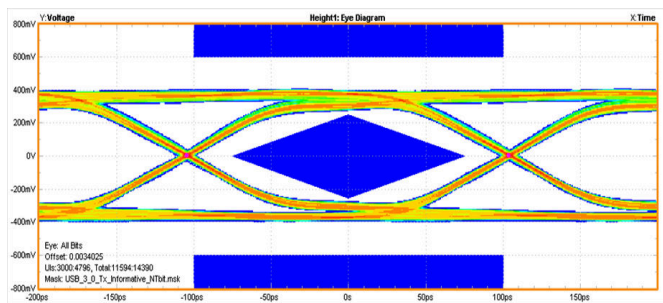
This family of devices are passive ESD protection devices and there is no need to power them. Care should be taken to not violate the maximum voltage specification to ensure that the device functions properly. The D+ and D- lines share a TVS diode which can tolerate up to 6 V.

10 Layout

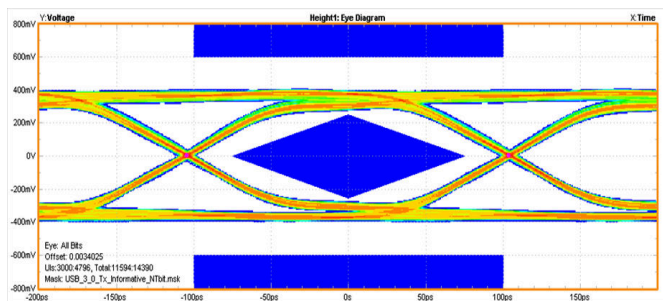
10.1 Layout Guidelines

- The optimum placement is as close to the connector as possible.
 - EMI during an ESD event can couple from the trace being struck to other nearby unprotected traces, resulting in early system failures.
 - The PCB designer needs to minimize the possibility of EMI coupling by keeping any unprotected traces away from the protected traces which are between the TVS and the connector.
- Route the protected traces as straight as possible.
- Eliminate any sharp corners on the protected traces between the TVS and the connector by using rounded corners with the largest radii possible.
 - Electric fields tend to build up on corners, increasing EMI coupling.

Refer to [Figure 10-1](#), the TPD2EUSB30/A are offered in space saving DRT package. The DRT is a 1-mm × 1-mm package with flow-through pin-mapping for the high-speed differential lines. The TPD4EUSB30 is offered in space saving DQA package. The DQA is a 1-mm × 2.5-mm package with flow-through pin-mapping for the high-speed differential lines. It is recommended to place the package right next to the USB 3.0 connector. The GND pin should be connected to GND plane of the board through a large VIA. If a dedicated GND plane is not present right underneath, it is recommended to route to the GND plane through a wide trace. The current associated with IEC ESD stress can be in the range of 30Amps or higher momentarily. A good, low impedance GND path ensures the system robustness against IEC ESD stress.

The TPDxEUSB30/A can provide system level ESD protection to the high-speed differential ports (> 5 Gbps data rate). The flow-through package offers flexibility for board routing with traces up to 15 mils wide. It allows the differential signal pairs couple together right after they touch the ESD ports of the TPDxEUSB30/A.

10.2 Layout Examples

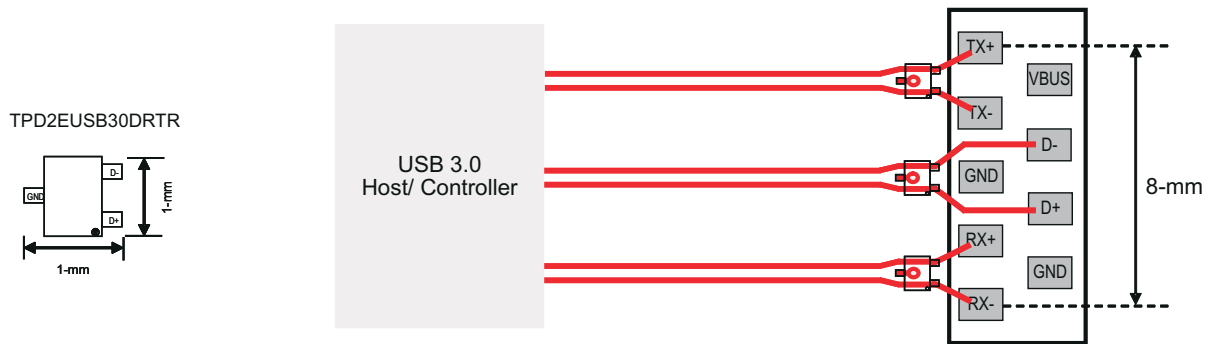

Three TPD2EUSB30 to Protect USB3.0 Class A connector (One Layer Routing)

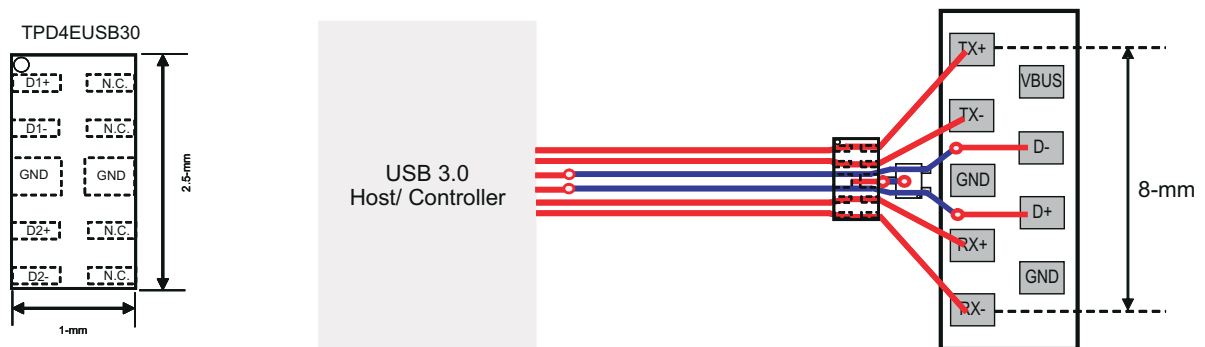

One TPD4EUSB30 & One TPD2EUSB30 to Protect USB3.0 Class A connector (Two Layer Routing)

图 10-1. TPDxUSB30/A at the USB3.0 Class A Connector



图 10-2. TPDxEUSB30/A EVM - TPD4EUSB30 Side



图 10-3. TPDxEUSB30/A EVM - TPD2EUSB30/A Side

11 Device and Documentation Support

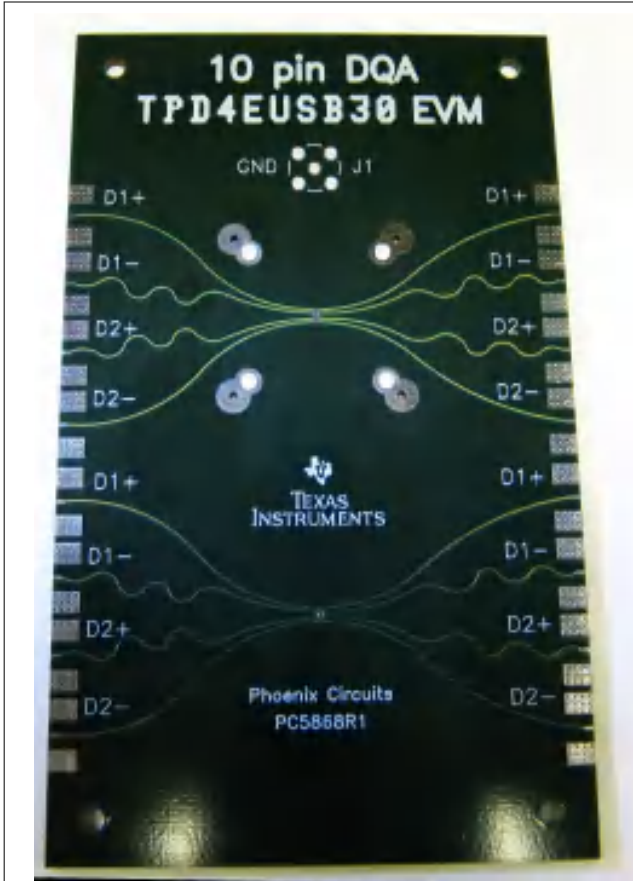
11.1 接收文档更新通知

要接收文档更新通知，请导航至 ti.com 上的器件产品文件夹。点击 [订阅更新](#) 进行注册，即可每周接收产品信息更改摘要。有关更改的详细信息，请查看任何已修订文档中包含的修订历史记录。

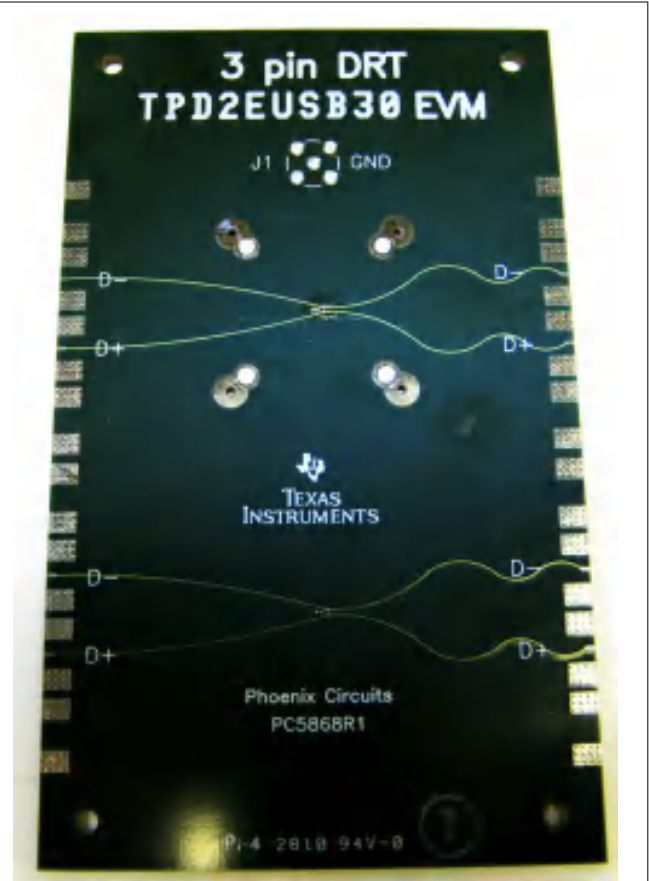
11.2 支持资源

TI E2E™ [支持论坛](#) 是工程师的重要参考资料，可直接从专家获得快速、经过验证的解答和设计帮助。搜索现有解答或提出自己的问题可获得所需的快速设计帮助。

链接的内容由各个贡献者“按原样”提供。这些内容并不构成 TI 技术规范，并且不一定反映 TI 的观点；请参阅 TI 的《[使用条款](#)》。

11.3 Trademarks

TI E2E™ is a trademark of Texas Instruments.
所有商标均为其各自所有者的财产。

11.4 Electrostatic Discharge Caution



This integrated circuit can be damaged by ESD. Texas Instruments recommends that all integrated circuits be handled with appropriate precautions. Failure to observe proper handling and installation procedures can cause damage.

ESD damage can range from subtle performance degradation to complete device failure. Precision integrated circuits may be more susceptible to damage because very small parametric changes could cause the device not to meet its published specifications.

11.5 术语表

[TI 术语表](#) 本术语表列出并解释了术语、首字母缩略词和定义。

12 Mechanical, Packaging, and Orderable Information

The following pages include mechanical, packaging, and orderable information. This information is the most current data available for the designated devices. This data is subject to change without notice and revision of this document. For browser-based versions of this data sheet, refer to the left-hand navigation.

PACKAGING INFORMATION

Orderable Device	Status (1)	Package Type	Package Drawing	Pins	Package Qty	Eco Plan (2)	Lead finish/ Ball material (6)	MSL Peak Temp (3)	Op Temp (°C)	Device Marking (4/5)	Samples
TPD2EUSB30ADRTR	ACTIVE	SOT-9X3	DRT	3	3000	RoHS & Green	NIPDAU	Level-1-260C-UNLIM	-40 to 85	5S	Samples
TPD2EUSB30DRTR	ACTIVE	SOT-9X3	DRT	3	3000	RoHS & Green	NIPDAU	Level-1-260C-UNLIM	-40 to 85	5P	Samples
TPD4EUSB30DQAR	ACTIVE	USON	DQA	10	3000	RoHS & Green	NIPDAU NIPDAUAG	Level-1-260C-UNLIM	-40 to 85	(667, 66O, 66R, 66V, BMR)	Samples

(1) The marketing status values are defined as follows:

ACTIVE: Product device recommended for new designs.

LIFEBUY: TI has announced that the device will be discontinued, and a lifetime-buy period is in effect.

NRND: Not recommended for new designs. Device is in production to support existing customers, but TI does not recommend using this part in a new design.

PREVIEW: Device has been announced but is not in production. Samples may or may not be available.

OBSOLETE: TI has discontinued the production of the device.

(2) **RoHS:** TI defines "RoHS" to mean semiconductor products that are compliant with the current EU RoHS requirements for all 10 RoHS substances, including the requirement that RoHS substance do not exceed 0.1% by weight in homogeneous materials. Where designed to be soldered at high temperatures, "RoHS" products are suitable for use in specified lead-free processes. TI may reference these types of products as "Pb-Free".

RoHS Exempt: TI defines "RoHS Exempt" to mean products that contain lead but are compliant with EU RoHS pursuant to a specific EU RoHS exemption.

Green: TI defines "Green" to mean the content of Chlorine (Cl) and Bromine (Br) based flame retardants meet JS709B low halogen requirements of <=1000ppm threshold. Antimony trioxide based flame retardants must also meet the <=1000ppm threshold requirement.

(3) MSL, Peak Temp. - The Moisture Sensitivity Level rating according to the JEDEC industry standard classifications, and peak solder temperature.

(4) There may be additional marking, which relates to the logo, the lot trace code information, or the environmental category on the device.

(5) Multiple Device Markings will be inside parentheses. Only one Device Marking contained in parentheses and separated by a "~" will appear on a device. If a line is indented then it is a continuation of the previous line and the two combined represent the entire Device Marking for that device.

(6) Lead finish/Ball material - Orderable Devices may have multiple material finish options. Finish options are separated by a vertical ruled line. Lead finish/Ball material values may wrap to two lines if the finish value exceeds the maximum column width.

Important Information and Disclaimer:The information provided on this page represents TI's knowledge and belief as of the date that it is provided. TI bases its knowledge and belief on information provided by third parties, and makes no representation or warranty as to the accuracy of such information. Efforts are underway to better integrate information from third parties. TI has taken and continues to take reasonable steps to provide representative and accurate information but may not have conducted destructive testing or chemical analysis on incoming materials and chemicals. TI and TI suppliers consider certain information to be proprietary, and thus CAS numbers and other limited information may not be available for release.

In no event shall TI's liability arising out of such information exceed the total purchase price of the TI part(s) at issue in this document sold by TI to Customer on an annual basis.

TAPE AND REEL INFORMATION

QUADRANT ASSIGNMENTS FOR PIN 1 ORIENTATION IN TAPE

*All dimensions are nominal

Device	Package Type	Package Drawing	Pins	SPQ	Reel Diameter (mm)	Reel Width W1 (mm)	A0 (mm)	B0 (mm)	K0 (mm)	P1 (mm)	W (mm)	Pin1 Quadrant
TPD2EUSB30ADRTR	SOT-9X3	DRT	3	3000	180.0	8.4	1.16	1.16	0.63	4.0	8.0	Q3
TPD2EUSB30DRTR	SOT-9X3	DRT	3	3000	180.0	8.4	1.16	1.16	0.63	4.0	8.0	Q3
TPD4EUSB30DQAR	USON	DQA	10	3000	180.0	9.5	1.18	2.68	0.72	4.0	8.0	Q1
TPD4EUSB30DQAR	USON	DQA	10	3000	180.0	8.4	1.23	2.7	0.6	4.0	8.0	Q1
TPD4EUSB30DQAR	USON	DQA	10	3000	180.0	9.5	1.23	2.7	0.7	4.0	8.0	Q1

TAPE AND REEL BOX DIMENSIONS

*All dimensions are nominal

Device	Package Type	Package Drawing	Pins	SPQ	Length (mm)	Width (mm)	Height (mm)
TPD2EUSB30ADRTR	SOT-9X3	DRT	3	3000	183.0	183.0	20.0
TPD2EUSB30DRTR	SOT-9X3	DRT	3	3000	183.0	183.0	20.0
TPD4EUSB30DQAR	USON	DQA	10	3000	189.0	185.0	36.0
TPD4EUSB30DQAR	USON	DQA	10	3000	203.2	196.8	33.3
TPD4EUSB30DQAR	USON	DQA	10	3000	184.0	184.0	19.0

DQA0010A

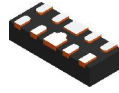

PACKAGE OUTLINE

USON - 0.55 mm max height

PLASTIC SMALL OUTLINE - NO LEAD

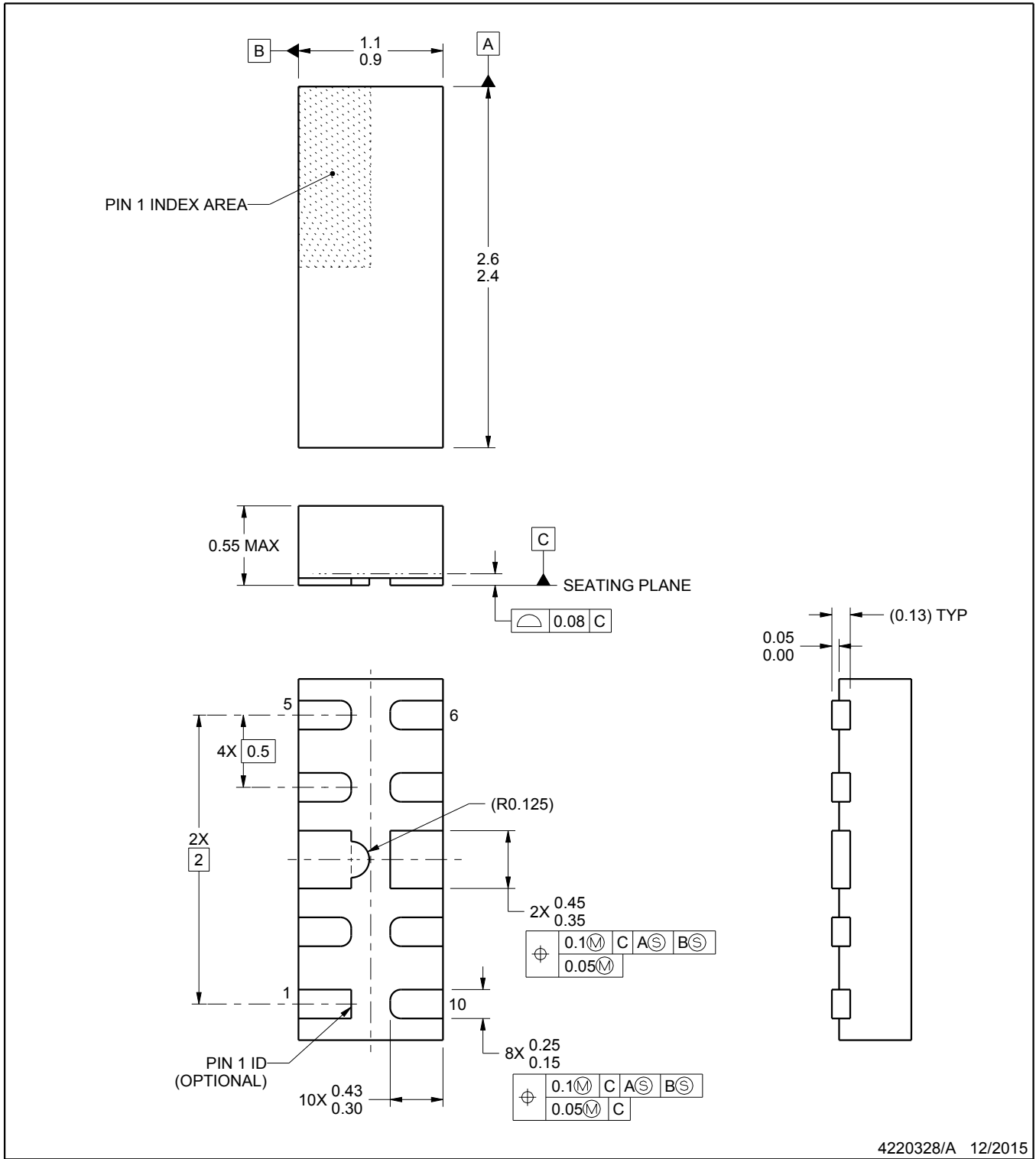

4220328/A 12/2015

NOTES:

1. All linear dimensions are in millimeters. Any dimensions in parenthesis are for reference only. Dimensioning and tolerancing per ASME Y14.5M.
2. This drawing is subject to change without notice.

EXAMPLE BOARD LAYOUT

DQA0010A

USON - 0.55 mm max height

PLASTIC SMALL OUTLINE - NO LEAD

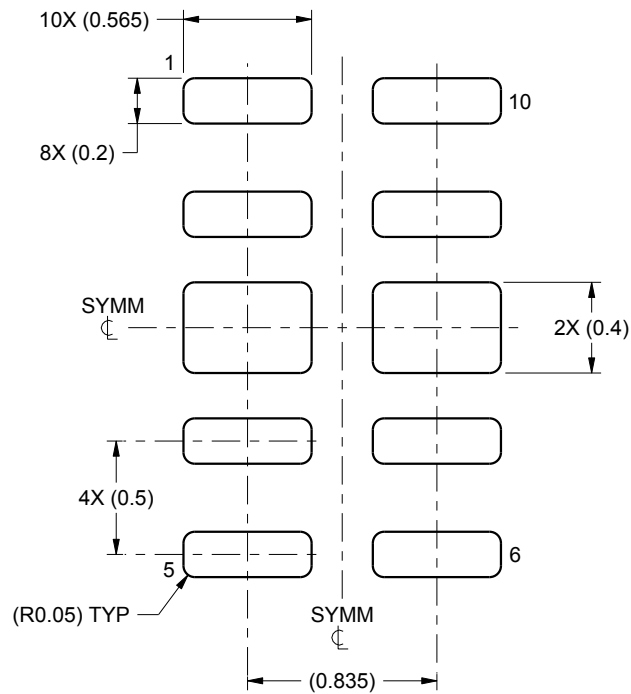

LAND PATTERN EXAMPLE
SCALE:30X

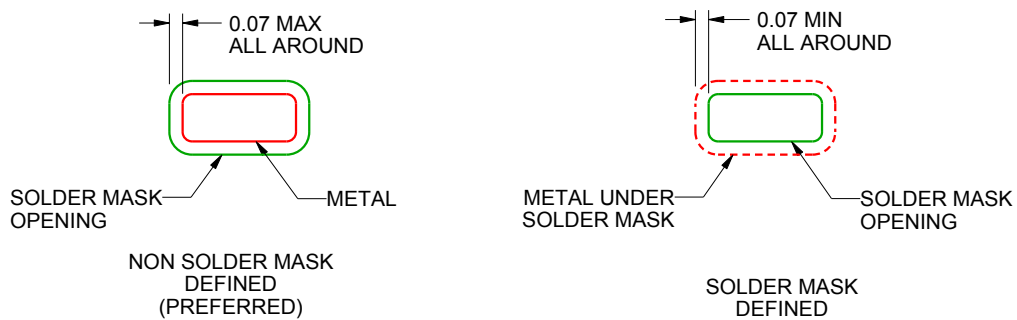

SOLDER MASK DETAILS

4220328/A 12/2015

NOTES: (continued)

3. For more information, see Texas Instruments literature number SLUA271 (www.ti.com/lit/slua271).

EXAMPLE STENCIL DESIGN

DQA0010A

USON - 0.55 mm max height

PLASTIC SMALL OUTLINE - NO LEAD

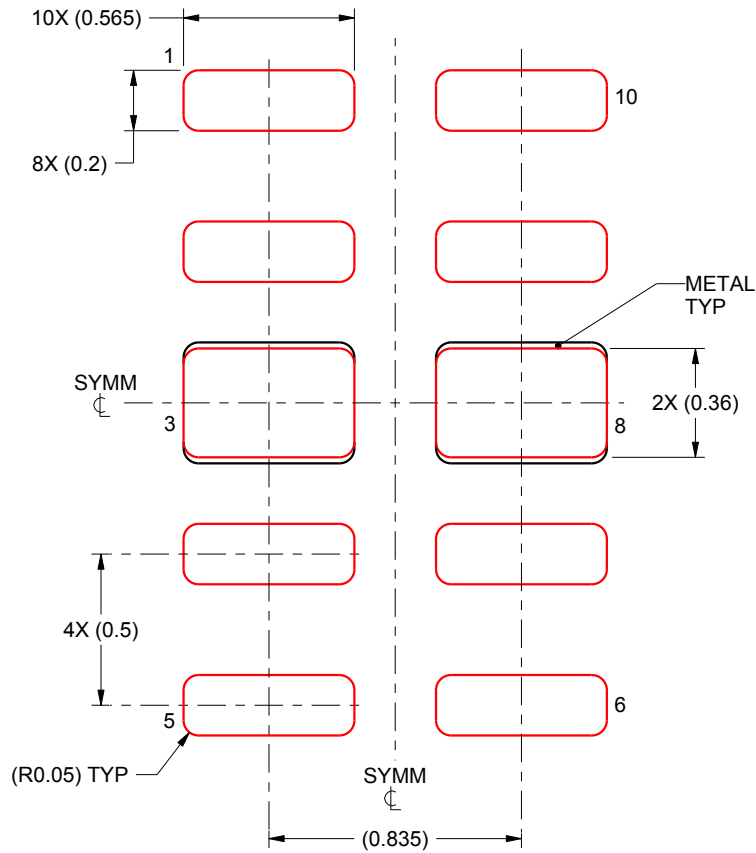

SOLDER PASTE EXAMPLE
BASED ON 0.1 mm THICK STENCIL

EXPOSED PADS 3 & 8:
90% PRINTED SOLDER COVERAGE BY AREA UNDER PACKAGE
SCALE:40X

4220328/A 12/2015

NOTES: (continued)

4. Laser cutting apertures with trapezoidal walls and rounded corners may offer better paste release. IPC-7525 may have alternate design recommendations.

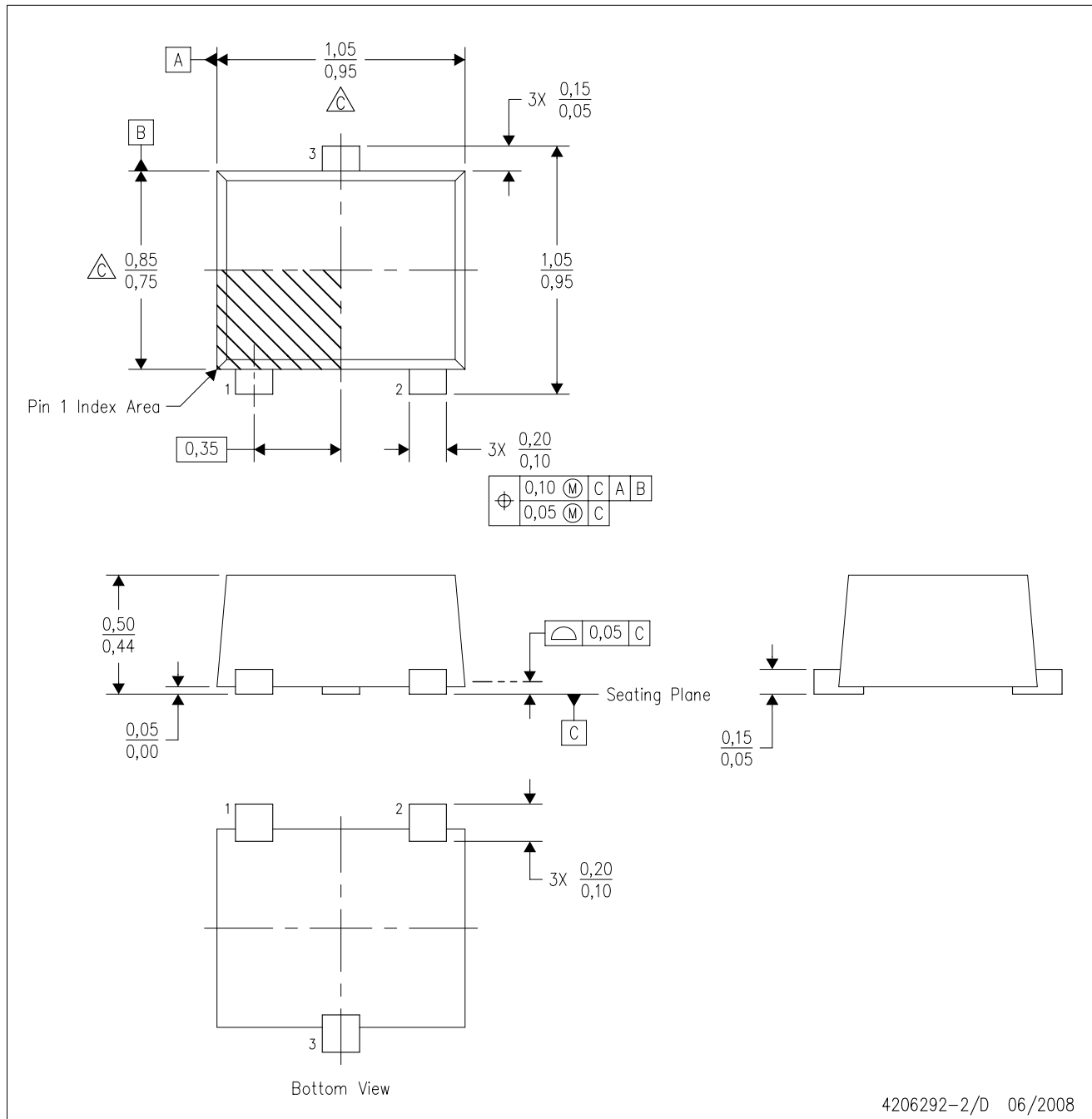

4206292-2/D 06/2008

- NOTES:
- A. All linear dimensions are in millimeters. Dimensioning and tolerancing per ASME Y14.5M-1994.
 - B. This drawing is subject to change without notice.
 - C. Body dimensions do not include mold flash, interlead flash, protrusions, or gate burrs. Mold flash, interlead flash, protrusions, or gate burrs shall not exceed 0,10 per end or side.
 - D. JEDEC package registration is pending.

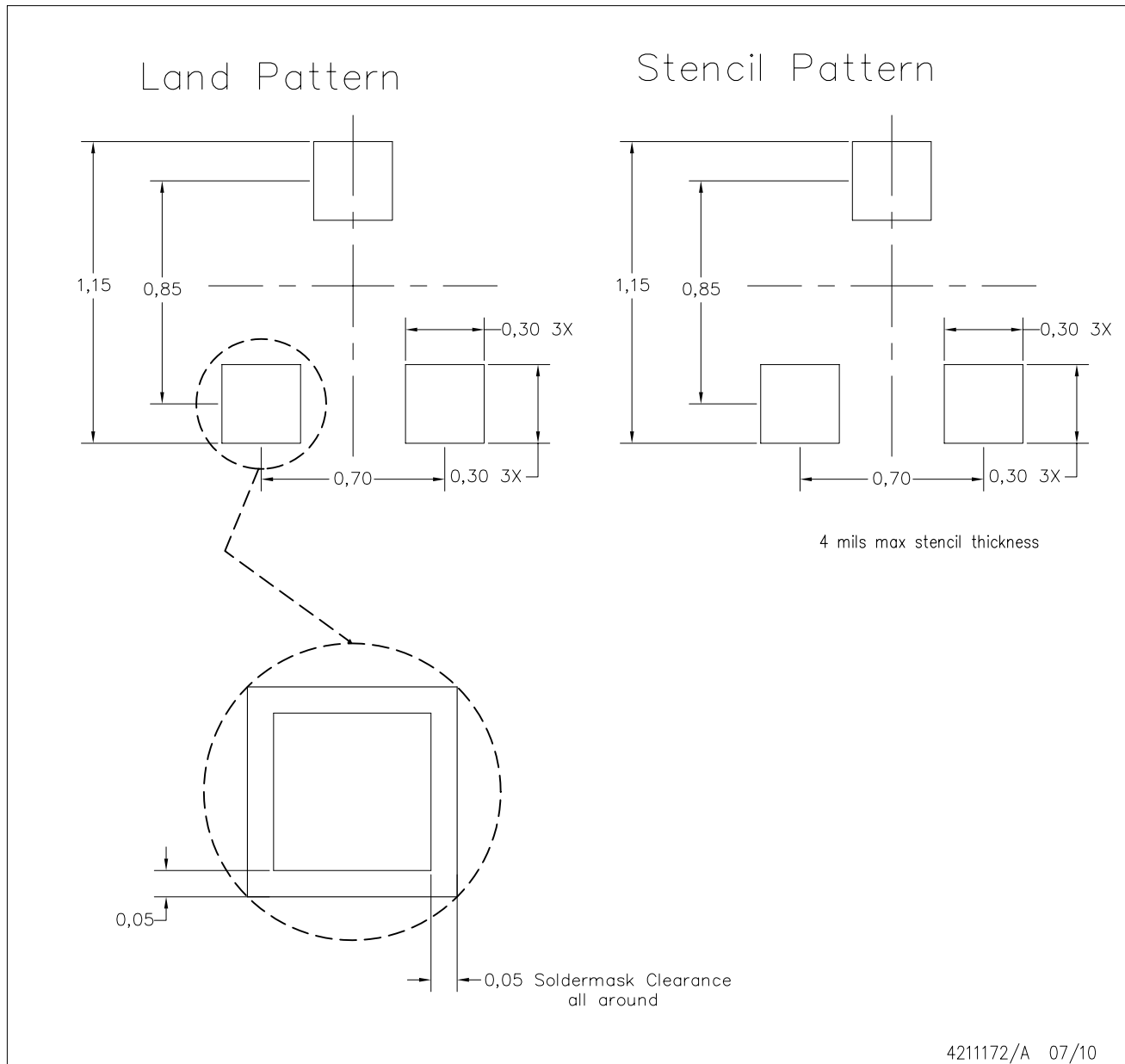

4211172/A 07/10

- NOTES:
- A. All linear dimensions are in millimeters.
 - B. This drawing is subject to change without notice.
 - C. Publication IPC-7351 is recommended for alternate designs.
 - D. Customers should contact their board fabrication site for minimum solder mask web tolerances between signal pads.
 - E. Maximum stencil thickness 0,1016 mm (4 mils). All linear dimensions are in millimeters.
 - F. Laser cutting apertures with trapezoidal walls and also rounding corners will offer better paste release. Customers should contact their board assembly site for stencil design recommendations. Refer to IPC 7525 for stencil design considerations.
 - G. Side aperture dimensions over-print land for acceptable area ratio > 0.66. Customer may reduce side aperture dimensions if stencil manufacturing process allows for sufficient release at smaller opening.

重要声明和免责声明

TI“按原样”提供技术和可靠性数据（包括数据表）、设计资源（包括参考设计）、应用或其他设计建议、网络工具、安全信息和其他资源，不保证没有瑕疵且不做任何明示或暗示的担保，包括但不限于对适销性、某特定用途方面的适用性或不侵犯任何第三方知识产权的暗示担保。

这些资源可供使用 TI 产品进行设计的熟练开发人员使用。您将自行承担以下全部责任：(1) 针对您的应用选择合适的 TI 产品，(2) 设计、验证并测试您的应用，(3) 确保您的应用满足相应标准以及任何其他功能安全、信息安全、监管或其他要求。

这些资源如有变更，恕不另行通知。TI 授权您仅可将这些资源用于研发本资源所述的 TI 产品的应用。严禁对这些资源进行其他复制或展示。您无权使用任何其他 TI 知识产权或任何第三方知识产权。您应全额赔偿因在这些资源的使用中对 TI 及其代表造成的任何索赔、损害、成本、损失和债务，TI 对此概不负责。

TI 提供的产品受 [TI 的销售条款](#) 或 [ti.com](#) 上其他适用条款/TI 产品随附的其他适用条款的约束。TI 提供这些资源并不会扩展或以其他方式更改 TI 针对 TI 产品发布的适用的担保或担保免责声明。

TI 反对并拒绝您可能提出的任何其他或不同的条款。

邮寄地址：Texas Instruments, Post Office Box 655303, Dallas, Texas 75265

Copyright © 2022，德州仪器 (TI) 公司